

Transient Voltage Suppressors (TVS) Data Sheet

Features

- For surface mounted applications in order to optimize board space
- Low profile package
- Built-in strain relief
- Glass passivated junction
- Low inductance
- Excellent clamping capability
- 1500W peak pulse power capability at 10/1000 μ s waveform,
- repetition rate (duty cycle): 0.01%
- Fast response time
- Typical I_R less than 1 μ A above 12V
- High Temperature soldering: 260 $^{\circ}$ C/10 seconds at terminals
- Plastic package has underwriters laboratory flammability 94V-0
- Meets MSL level 1, per J-STD-020
- AEC-Q101 qualified (Automotive grade with suffix "Q".)
- Expsemi electronics
- UL Certification:E492977



Mechanical Data

- Case: JEDEC DO-214AA. Molded plastic over glass passivated
- junction Terminal: Solder plated, solderable per MIL-STD-750, Method
- 2026 Polarity: Color band denotes cathode except bi-directional models

Applications

- AC/DC power supply
- I/O interface
- Low frequency signal transmission line

Maximum Ratings and Characteristics

Ratings at 25 $^{\circ}$ C ambient temperature unless otherwise specified.

Rating	Symbol	Value	Units
Peak pulse power dissipation at 10/1000 μ s waveform (Note1, Note2, Fig.1)	P_{PPM}	Minimum 1500	Watts
Peak pulse current of at 10/1000 μ s waveform (Note 1, Fig.3)	I_{PPM}	See Table	Amps
Steady state power dissipation at $T_A=50^{\circ}$ C (Fig.5)	$P_{M(AV)}$	6.5	Watts
Peak forward surge current, 8.3ms single half sine-wave superimposed on rated load, (JEDEC Method) (Note3, Fig.6)	I_{FSM}	200	Amps
Operating junction and Storage Temperature Range.	T_J, T_{STG}	-65 to +150	$^{\circ}$ C
Typical thermal resistance junction to lead	$R_{\theta JL}$	15	$^{\circ}$ C/W
Typical thermal resistance junction to ambient	$R_{\theta JA}$	75	$^{\circ}$ C/W

Notes: 1. Non-repetitive current pulse, per Fig.3 and derated above $T_A=25^{\circ}$ C per Fig.2.

2. Mounted on 8.0mm \times 8.0mm copper pads to each terminal.

3. 8.3ms single half sine-wave, or equivalent square wave, duty cycle=4 pulses per minutes maximum.

Electrical Characteristics (T_A=25°C)

Part Number		Device Marking Code		Reverse Stand-Off Voltage	Breakdown Voltage @I _T	Test Current	Maximum Clamping Voltage @I _{PP}	Peak Pulse Current	Reverse Leakage @V _{RWM}
Unidirectional	Bidirectional	UNI	BI	V _{RWM} (V)	V _{BR} (V)	I _T (mA)	V _C (V)	I _{PP} (A)	I _R (μA)
1.5SMB6.8A	1.5SMB6.8CA	6V8A	6V8C	5.80	6.45~7.14	10	10.5	144.8	1000
1.5SMB7.5A	1.5SMB7.5CA	7V5A	7V5C	6.40	7.13~7.88	10	11.3	134.5	500
1.5SMB8.2A	1.5SMB8.2CA	8V2A	8V2C	7.02	7.79~8.61	10	12.1	125.6	200
1.5SMB9.1A	1.5SMB9.1CA	9V1A	9V1C	7.78	8.65~9.55	1	13.4	113.4	50
1.5SMB10A	1.5SMB10CA	10A	10C	8.55	9.50~10.50	1	14.5	104.8	10
1.5SMB11A	1.5SMB11CA	11A	11C	9.40	10.50~11.60	1	15.6	97.4	5
1.5SMB12A	1.5SMB12CA	12A	12C	10.20	11.40~12.60	1	16.7	91.0	5
1.5SMB13A	1.5SMB13CA	13A	13C	11.10	12.40~13.70	1	18.2	83.5	1
1.5SMB15A	1.5SMB15CA	15A	15C	12.80	14.30~15.80	1	21.2	71.7	1
1.5SMB16A	1.5SMB16CA	16A	16C	13.60	15.20~16.80	1	22.5	67.6	1
1.5SMB18A	1.5SMB18CA	18A	18C	15.30	17.10~18.90	1	25.2	60.3	1
1.5SMB20A	1.5SMB20CA	20A	20C	17.10	19.00~21.00	1	27.7	54.9	1
1.5SMB22A	1.5SMB22CA	22A	22C	18.80	20.90~23.10	1	30.6	49.7	1
1.5SMB24A	1.5SMB24CA	24A	24C	20.50	22.80~25.20	1	33.2	45.8	1
1.5SMB27A	1.5SMB27CA	27A	27C	23.10	25.70~28.40	1	37.5	40.5	1
1.5SMB30A	1.5SMB30CA	30A	30C	25.60	28.50~31.50	1	41.4	36.7	1
1.5SMB33A	1.5SMB33CA	33A	33C	28.20	31.40~34.70	1	45.7	33.3	1
1.5SMB36A	1.5SMB36CA	36A	36C	30.80	34.20~37.80	1	49.9	30.5	1
1.5SMB39A	1.5SMB39CA	39A	39C	33.30	37.10~41.00	1	53.9	28.2	1
1.5SMB43A	1.5SMB43CA	43A	43C	36.80	40.90~45.20	1	59.3	25.6	1
1.5SMB47A	1.5SMB47CA	47A	47C	40.20	44.70~49.40	1	64.8	23.5	1
1.5SMB51A	1.5SMB51CA	51A	51C	43.60	48.50~53.60	1	70.1	21.7	1
1.5SMB56A	1.5SMB56CA	56A	56C	47.80	53.20~58.80	1	77.0	19.7	1
1.5SMB62A	1.5SMB62CA	62A	62C	53.00	58.90~65.10	1	85.0	17.9	1
1.5SMB68A	1.5SMB68CA	68A	68C	58.10	64.60~71.40	1	92.0	16.5	1
1.5SMB75A	1.5SMB75CA	75A	75C	64.10	71.30~78.80	1	103.0	14.8	1
1.5SMB82A	1.5SMB82CA	82A	82C	70.10	77.90~86.10	1	113.0	13.5	1

Electrical Characteristics ($T_A=25^{\circ}\text{C}$)

Part Number		Device Marking Code		Reverse Stand-Off Voltage	Breakdown Voltage @ I_T	Test Current	Maximum Clamping Voltage @ I_{PP}	Peak Pulse Current	Reverse Leakage @ V_{RWM}
Unidirectional	Bidirectional	UNI	BI	$V_{RWM}(V)$	$V_{BR}(V)$	$I_T(mA)$	$V_C(V)$	$I_{PP}(A)$	$I_R(\mu A)$
1.5SMB91A	1.5SMB91CA	91A	91C	77.80	86.50~95.50	1	125.0	12.2	1
1.5SMB100A	1.5SMB100CA	100A	100C	85.50	95.00~105.00	1	137.0	11.1	1
1.5SMB110A	1.5SMB110CA	110A	110C	94.00	105.00~116.00	1	152.0	10.0	1
1.5SMB120A	1.5SMB120CA	120A	120C	102.00	114.00~126.00	1	165.0	9.2	1
1.5SMB130A	1.5SMB130CA	130A	130C	111.00	124.00~137.00	1	179.0	8.5	1
1.5SMB150A	1.5SMB150CA	150A	150C	128.00	143.00~158.00	1	207.0	7.3	1
1.5SMB160A	1.5SMB160CA	160A	160C	136.00	152.00~168.00	1	219.0	6.9	1
1.5SMB170A	1.5SMB170CA	170A	170C	145.00	162.00~179.00	1	234.0	6.5	1
1.5SMB180A	1.5SMB180CA	180A	180C	154.00	171.00~189.00	1	246.0	6.2	1
1.5SMB200A	1.5SMB200CA	200A	200C	171.00	190.00~210.00	1	274.0	5.5	1
1.5SMB220A	1.5SMB220CA	220A	220C	185.00	209.00~231.00	1	328.0	4.6	1
1.5SMB250A	1.5SMB250CA	250A	250C	214.00	237.00~263.00	1	344.0	4.4	1
1.5SMB300A	1.5SMB300CA	300A	300C	256.00	285.00~315.00	1	414.0	3.7	1
1.5SMB350A	1.5SMB350CA	350A	350C	300.00	332.00~368.00	1	482.0	3.2	1
1.5SMB400A	1.5SMB400CA	400A	400C	342.00	380.00~420.00	1	548.0	2.8	1
1.5SMB440A	1.5SMB440CA	440A	440C	376.00	418.00~462.00	1	602.0	2.5	1
1.5SMB480A	1.5SMB480CA	480A	480C	408.00	456.00~504.00	1	658.0	2.3	1
1.5SMB510A	1.5SMB510CA	510A	510C	434.00	485.00~535.00	1	698.0	2.1	1
1.5SMB530A	1.5SMB530CA	530A	530C	450.00	503.50~556.50	1	725.0	2.1	1
1.5SMB540A	1.5SMB540CA	540A	540C	459.00	513.00~567.00	1	740.0	2.0	1
1.5SMB550A	1.5SMB550CA	550A	550C	467.00	522.50~577.50	1	760.0	2.0	1

Notes: For bidirectional type having V_{RWM} of 10V and less, the I_R limit is double.

Ratings and Characteristic Curves ($T_A=25^{\circ}\text{C}$ unless otherwise noted)

Figure 1. Peak Pulse Power Rating Curve

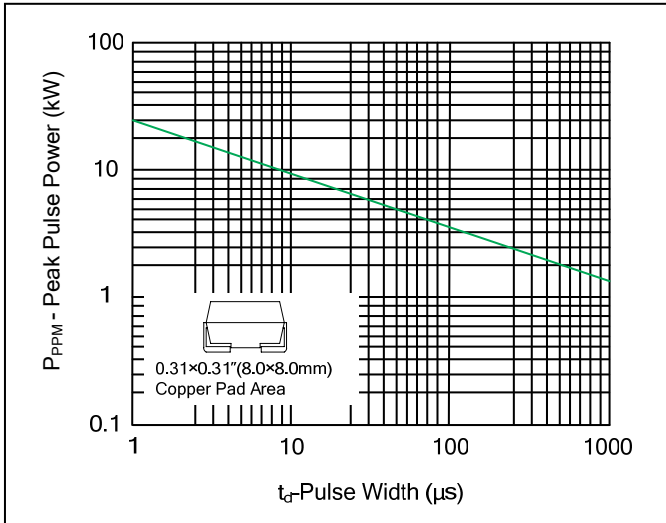

Figure 2. Pulse Derating Curve

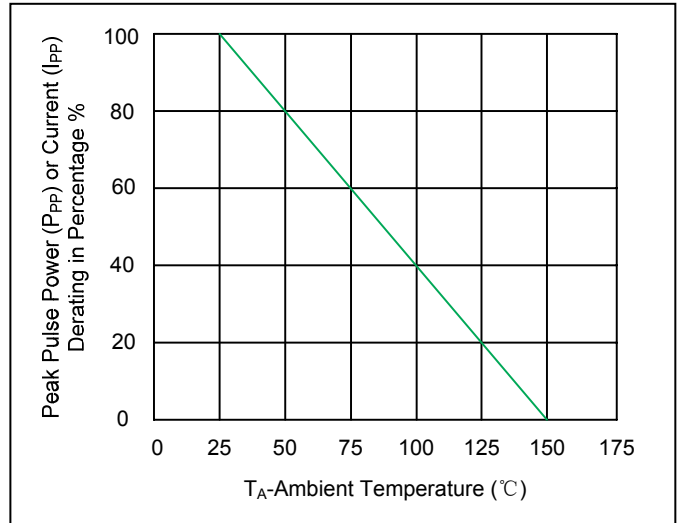

Figure 3. Pulse Waveform

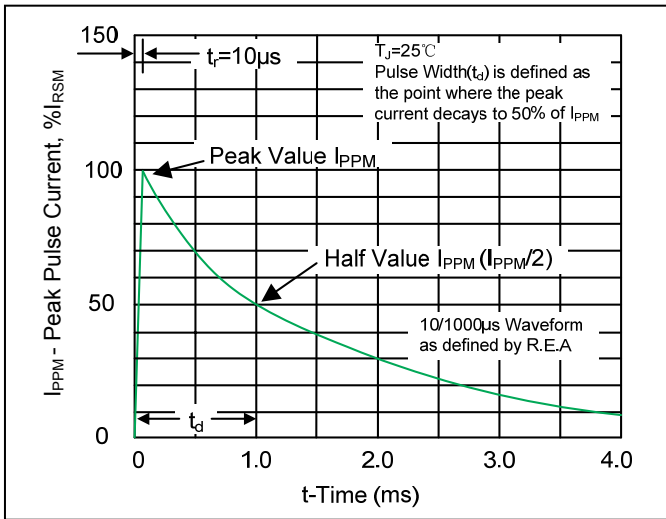

Figure 4. Typical Junction Capacitance

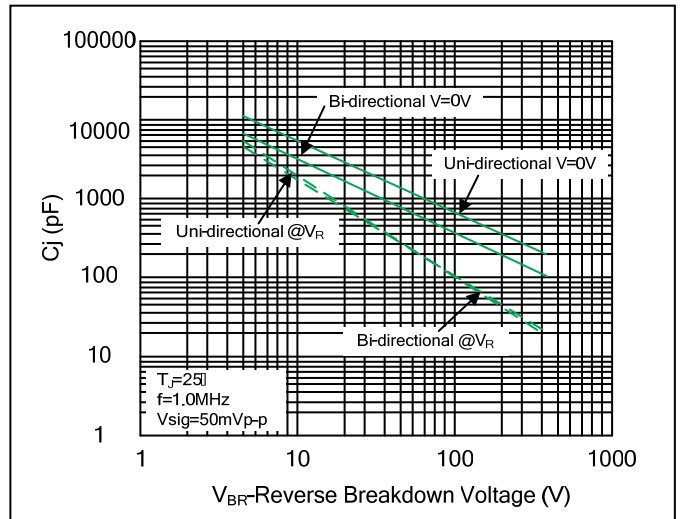

Figure 5. Steady State Power Dissipation Derating Curve

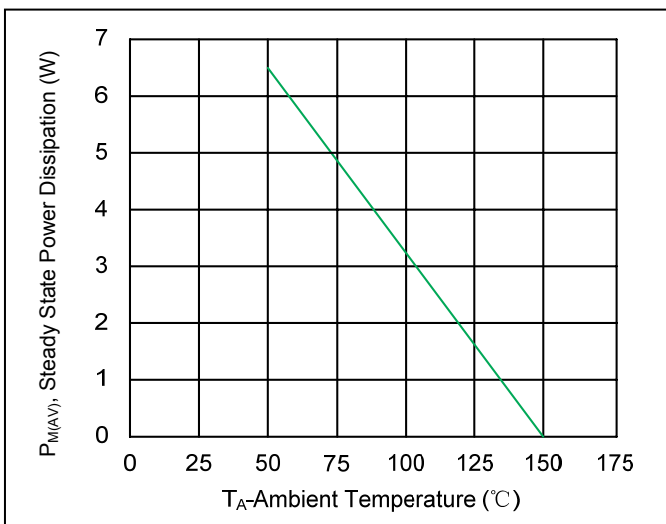
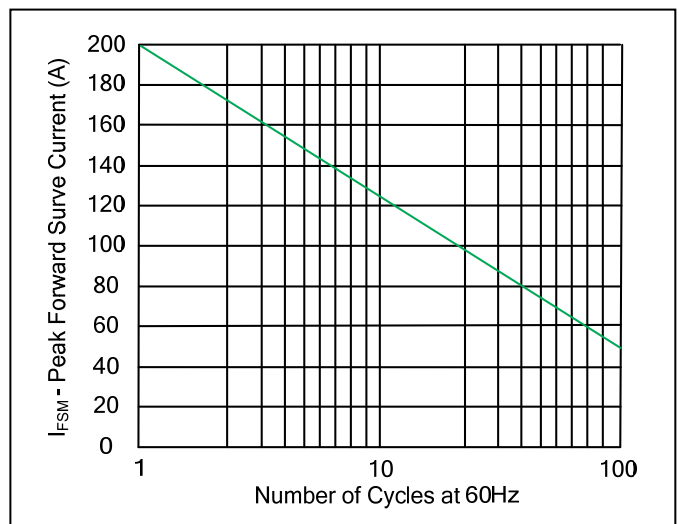

Figure 6. Maximum Non-Repetitive Forward Surge Current Uni-Directional Only



Recommended Soldering Conditions

Soldering Parameters

Reflow Condition		Lead-free assembly
Pre Heat	- Temperature Min ($T_{s(min)}$)	150°C
	- Temperature Max ($T_{s(max)}$)	200°C
	- Time (min to max) (t_s)	60 – 180 secs
Average ramp up rate (Liquidus Temp (T_A) to peak)		3°C/second max
$T_{s(max)}$ to T_A - Ramp-up Rate		3°C/second max
Reflow	- Temperature (T_A) (Liquidus)	217°C
	- Time (min to max) (t_s)	60 – 150 seconds
Peak Temperature (T_P)		260 ^{+0/-5} °C
Time within 5°C of actual peak Temperature (t_p)		20 – 40 seconds
Ramp-down Rate		6°C/second max
Time 25°C to peak Temperature (T_P)		8 minutes Max.
Do not exceed		260°C

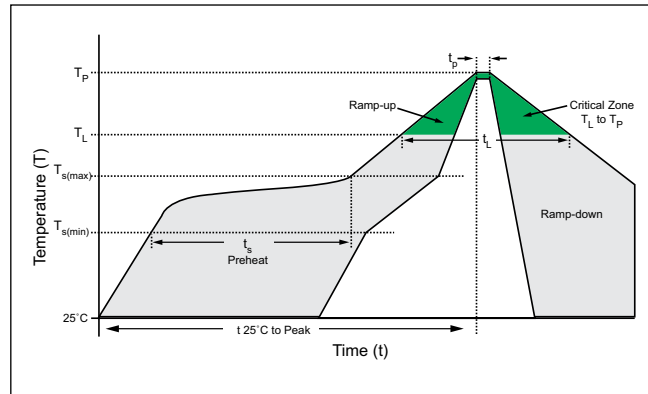

Physical Specifications

Case	JEDEC DO214AA. Molded plastic body over glass passivated junction
Polarity	Color band denotes positive end (cathode) except Bidirectional.
Terminal	Matte Tin-plated leads, Solderable per JESD22-B102

Environmental Specifications

High Temp. Storage	JESD22-A103
HTRB	JESD22-A108
Temperature Cycling	JESD22-A104
MSL	JEDEC-J-STD-020, Level 1
H3TRB	JESD22-A101
RSH	JESD22-A111

Dimensions

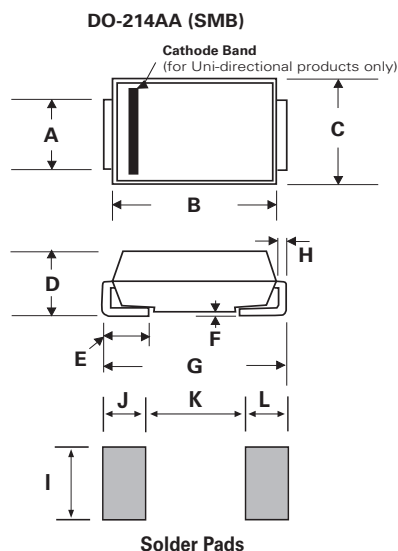

Dimensions	Inches		Millimeters	
	Min	Max	Min	Max
A	0.074	0.086	1.890	2.200
B	0.160	0.185	4.060	4.700
C	0.130	0.155	3.300	3.940
D	0.084	0.096	2.130	2.440
E	0.030	0.060	0.760	1.520
F	-	0.008	-	0.203
G	0.200	0.220	5.080	5.590
H	0.006	0.012	0.152	0.305
I	0.089	-	2.260	-
J	0.085	-	2.160	-
K	-	0.107	-	2.740
L	0.085	-	2.160	-

Part Numbering System

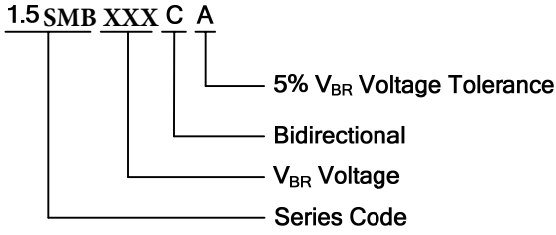

Part Marking System

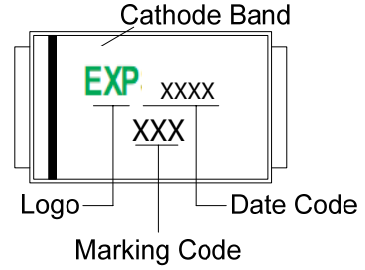

Packaging

Part number	Component Package	Quantity	Packaging Option	Packaging Specification
1.5SMBxxxXX	DO-214AA	3000	Tape & Reel - 16mm tape/13" reel	EIA STD RS-481